

New Products

11-1~11-3

• New Energy

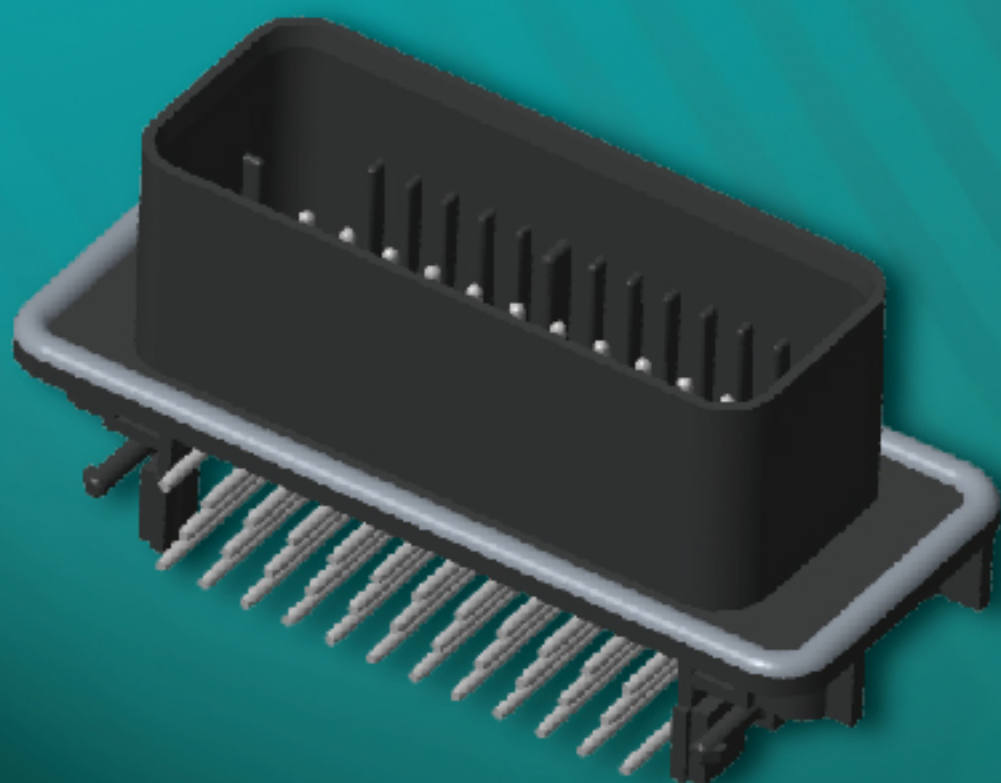

AMTEK Technology Co., Ltd

CONNECTORS MANUFACTURER

New Energy Waterproof for vehicles Female Right Angle Type 35P

Specifications

Current Rating: 5A
 Voltage Rating: 250V AC
 Insulation Resistance: 5000 MΩ Min.
 Contact Resistance: 10mΩ Max.
 Withstand Voltage: 1000V
 Operation Temperature: -40°C to +105°C
 Waterproof Grade: IP67

Material

Insulator: PBT + 30% GF
 Contact Pin: Copper Alloy

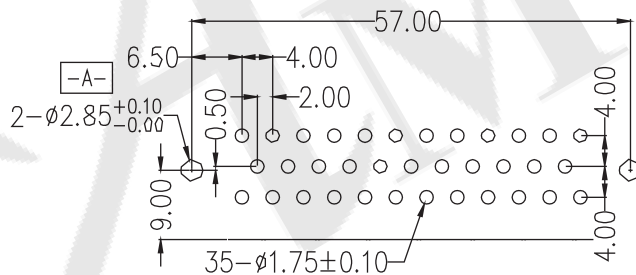
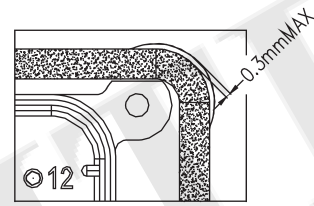
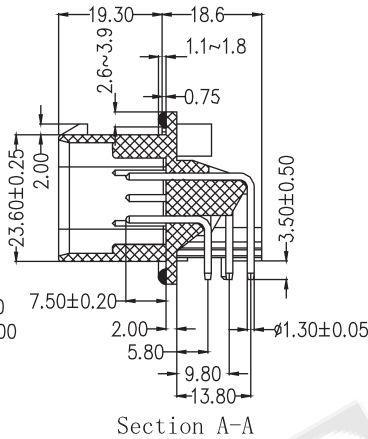
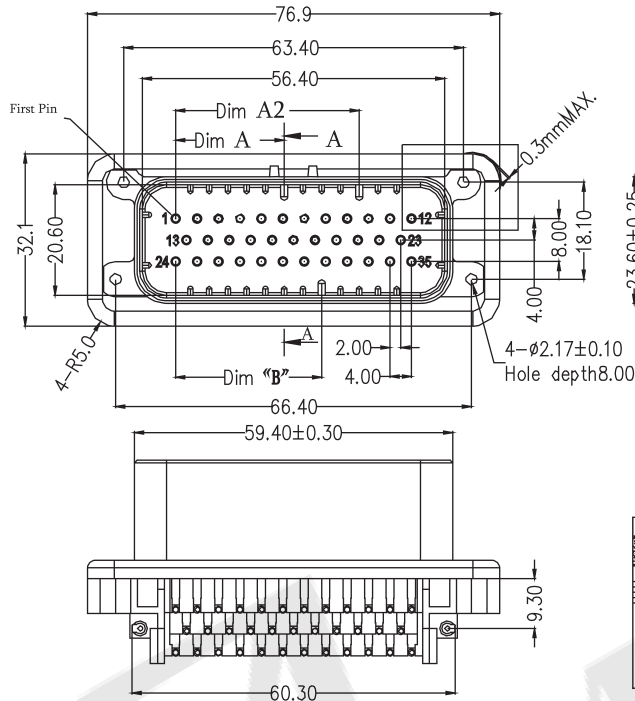
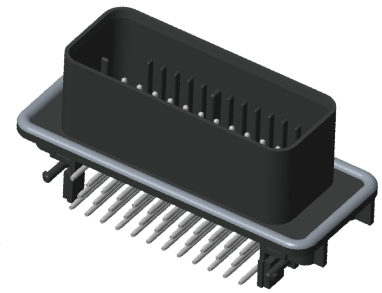

Recommended PCB Layout (Top Side)
 (PCB TOLERANCE ±0.05)

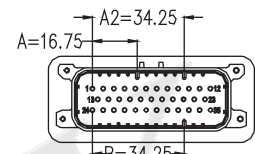

(BLUE)

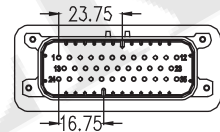

(WHITE)

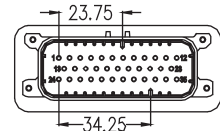

(ORANGE)

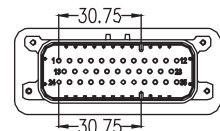

(GRAY)

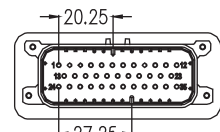

(BLACK)

Part No.	Main Color	Dim.A	Dim A2	Dim B
5NE20001FADRA-35XXBALN-01	Black	20.25		27.25
5NE20001FADRA-35XXWALN-01	White	23.75		16.75
5NE20001FADRA-35XXGALN-01	Gray	30.75		30.75
5NE20001FADRA-35XXUALN-01	Blue	16.75	34.25	34.25
5NE20001FADRA-35XXOALN-01	Orange	23.75		34.25

ORDER INFORMATION

5 N E 2 0 0 0 1 F A D R A - 3 5 X X X A L N - 0 1

200: Pitch 2.0

Series No.

DR: Dip R/A

No. of Contacts

G0: Gold Flash
 GB: Au 10u"
 T0: Tin Plated
 TM: Matte Tin

B: Black
 W: Natural
 G: Gray
 U: Blue
 O: Orange

L: RoHS + PBT

A: Tray, W/O Cap

New Energy

ROHS

New Energy Waterproof for vehicles Female Dip Straight Type 35P

Specifications

Current Rating: 5A
 Voltage Rating: 250V AC
 Insulation Resistance: 5000 MΩ Min.
 Contact Resistance: 10mΩ Max.
 Withstand Voltage: 1000V
 Operation Temperature: -40°C to +105°C
 Waterproof Grade: IP67

Material

Insulator: PBT + 30% GF
 Contact Pin: Copper Alloy

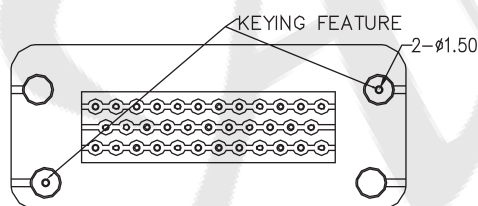
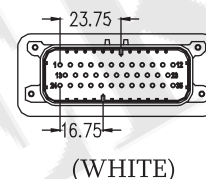
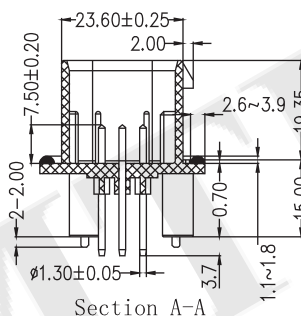
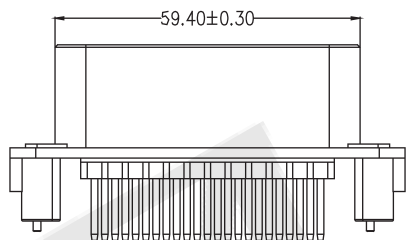
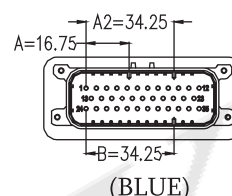
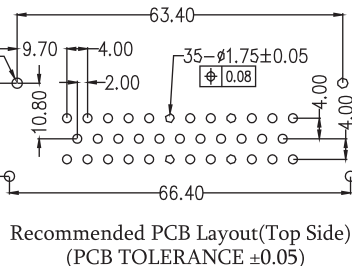
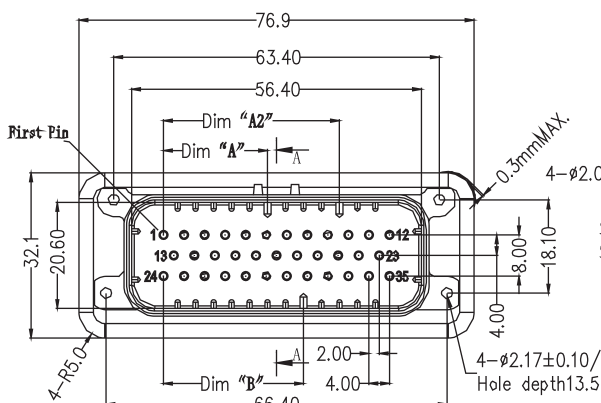
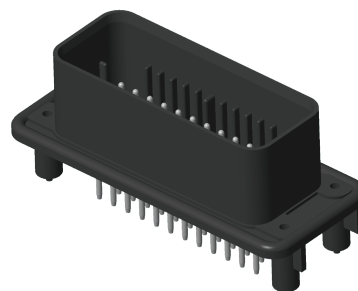

5NE20001FADSA-35XXWALN-01
 5NE20001FADSA-35XXUALN-01

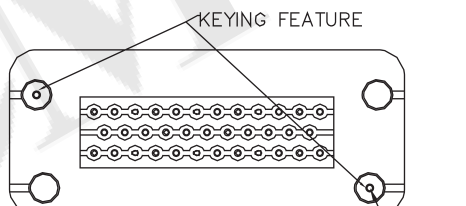

5NE20001FADSA-35XXBALN-01
 5NE20001FADSA-35XXGALN-01
 5NE20001FADSA-35XXOALN-01

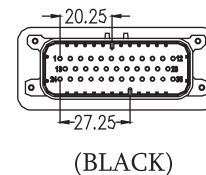
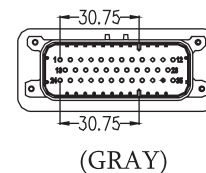
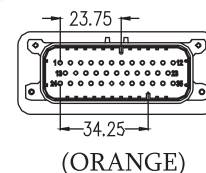

Part No.	Main Color	Dim.A	Dim A2	Dim B
5NE20001FADSA-35XXBALN-01	Black	20.25		27.25
5NE20001FADSA-35XXWALN-01	White	23.75		16.75
5NE20001FADSA-35XXGALN-01	Gray	30.75		30.75
5NE20001FADSA-35XXUALN-01	Blue	16.75	34.25	34.25
5NE20001FADSA-35XXOALN-01	Orange	23.75		34.25

ORDER INFORMATION

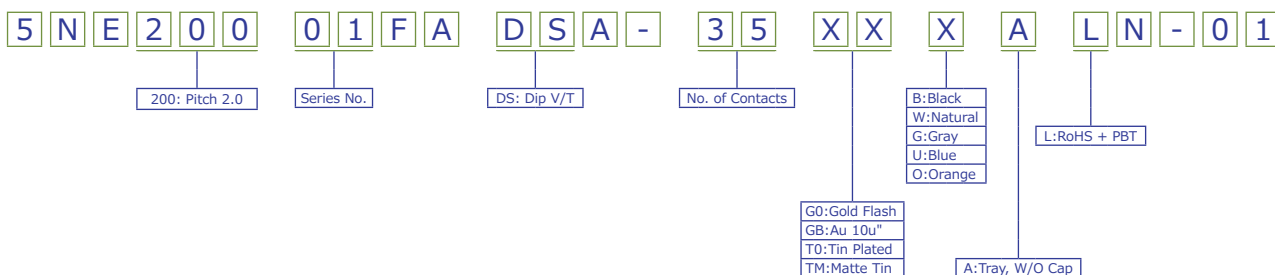

CONNECTORS MANUFACTURER



New Energy Car Connector Line End Socket 35P

Specifications

Operation Temperature: -40°C to 105°C
 Waterproof grade: IP67
 Wire Size Range: 20-16A WG(1.0-1.5mm²)

Material

Housing Material: PBT

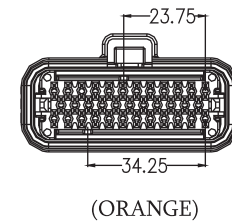
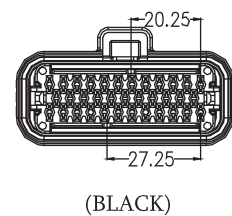
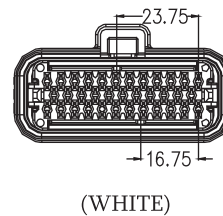
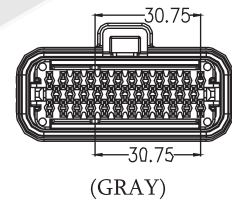
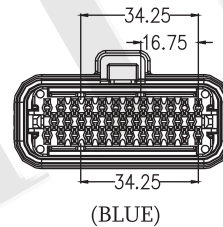
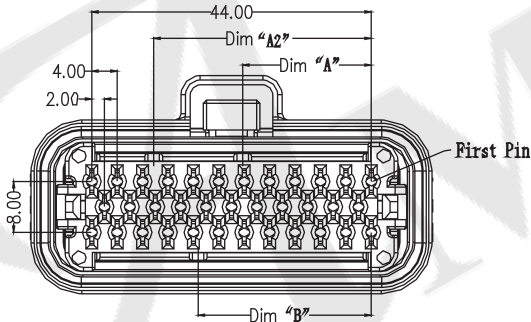
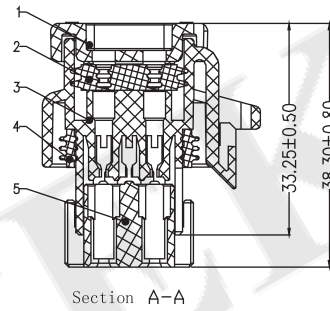
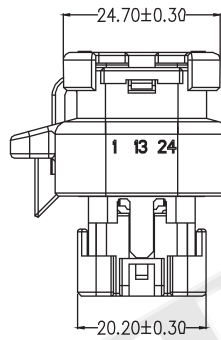
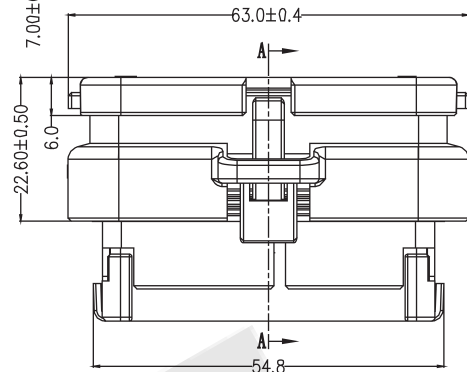
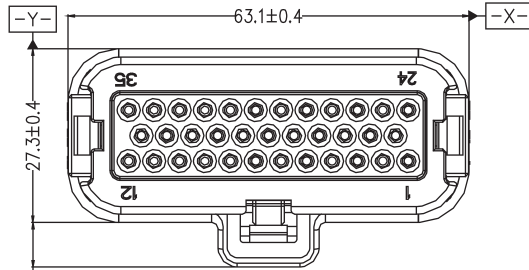
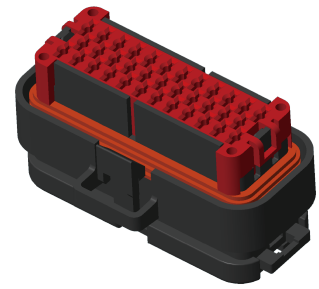

Part No.	Main Color	Dim.A	Dim A2	Dim B
5NE20001FHNNNA-35NNBALN-01	Black	20.25		27.25
5NE20001FHNNNA-35NNWALN-01	White	23.75		16.75
5NE20001FHNNNA-35NNGALN-01	Gray	30.75		30.75
5NE20001FHNNNA-35NNUALN-01	Blue	16.75	34.25	34.25
5NE20001FHNNNA-35NNOALN-01	Orange	23.75		34.25

ORDER INFORMATION

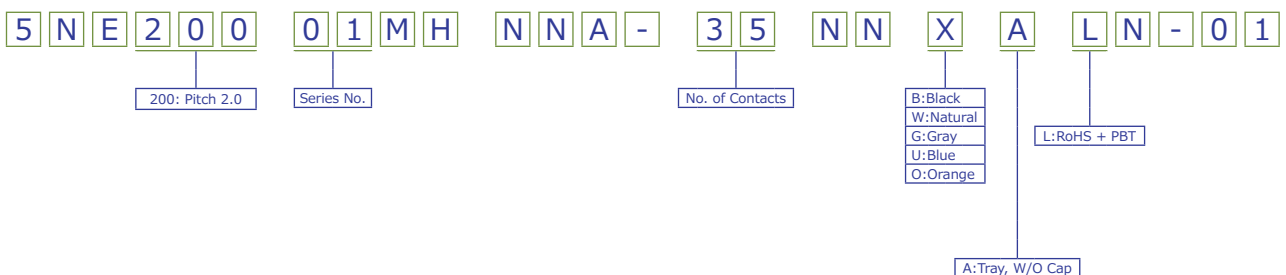

New Energy

ROHS